

# Designer's™ Data Sheet

## Schottky Power Rectifier

### Surface Mount Power Package

**MBRS1100T3**

Motorola Preferred Device

**SCHOTTKY BARRIER  
RECTIFIER  
1.0 AMPERE  
100 VOLTS**



**CASE 403A-03**

Schottky Power Rectifiers employ the use of the Schottky Barrier principle in a large area metal-to-silicon power diode. State-of-the-art geometry features epitaxial construction with oxide passivation and metal overlay contact. Ideally suited for low voltage, high frequency rectification, or as free wheeling and polarity protection diodes, in surface mount applications where compact size and weight are critical to the system. These state-of-the-art devices have the following features:

- Small Compact Surface Mountable Package with J-Bend Leads
- Rectangular Package for Automated Handling
- Highly Stable Oxide Passivated Junction
- High Blocking Voltage — 100 Volts
- 150°C Operating Junction Temperature
- Guardring for Stress Protection

#### Mechanical Characteristics

- Case: Epoxy, Molded
- Weight: 95 mg (approximately)
- Finish: All External Surfaces Corrosion Resistant and Terminal Leads are Readily Solderable
- Lead and Mounting Surface Temperature for Soldering Purposes: 260°C Max. for 10 Seconds
- Shipped in 12 mm Tape and Reel, 2500 units per reel
- Polarity: Notch in Plastic Body Indicates Cathode Lead
- Marking: B110

#### MAXIMUM RATINGS

Rating	Symbol	Value	Unit
Peak Repetitive Reverse Voltage Working Peak Reverse Voltage DC Blocking Voltage	$V_{RRM}$ $V_{RWM}$ $V_R$	100	Volts
Average Rectified Forward Current $T_L = 120^\circ\text{C}$ $T_L = 100^\circ\text{C}$	$I_{F(AV)}$	1.0 2.0	Amps
Nonrepetitive Peak Surge Current (Surge applied at rated load conditions halfwave, single phase, 60 Hz)	$I_{FSM}$	50	Amps
Operating Junction Temperature	$T_J$	- 65 to +150	°C
Voltage Rate of Change	dv/dt	10	V/ns

#### THERMAL CHARACTERISTICS

Thermal Resistance — Junction to Lead ( $T_L = 25^\circ\text{C}$ )	$R_{\theta JL}$	22	°C/W
--------------------------------------------------------------------	-----------------	----	------

#### ELECTRICAL CHARACTERISTICS

Maximum Instantaneous Forward Voltage (1) ( $i_F = 1.0\text{ A}$ , $T_J = 25^\circ\text{C}$ )	$V_F$	0.75	Volts
Maximum Instantaneous Reverse Current (1) (Rated dc Voltage, $T_J = 25^\circ\text{C}$ ) (Rated dc Voltage, $T_J = 100^\circ\text{C}$ )	$i_R$	0.5 5.0	mA

(1) Pulse Test: Pulse Width = 300  $\mu\text{s}$ , Duty Cycle  $\leq 2.0\%$ .

**Preferred** devices are Motorola recommended choices for future use and best overall value.

**Designer's Data for "Worst Case" Conditions** — The Designer's Data Sheet permits the design of most circuits entirely from the information presented. SOA Limit curves — representing boundaries on device characteristics — are given to facilitate "worst case" design.

**TYPICAL ELECTRICAL CHARACTERISTICS**

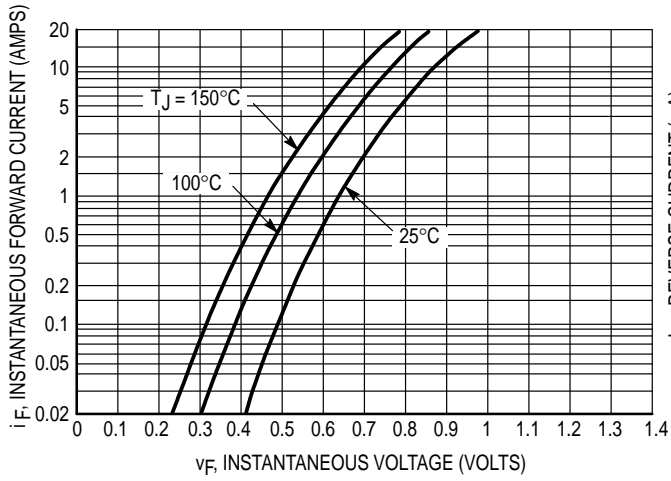

**Figure 1. Typical Forward Voltage**

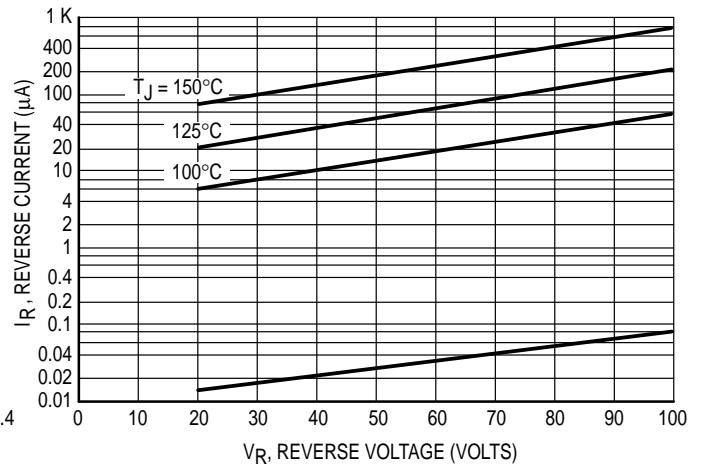

**Figure 2. Typical Reverse Current**

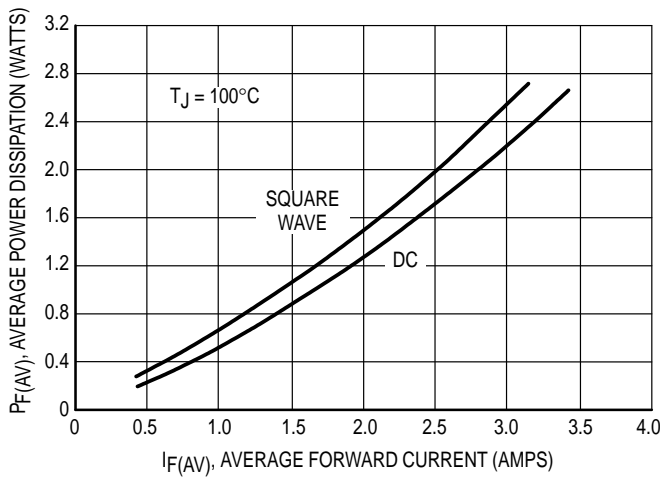

**Figure 3. Power Dissipation**

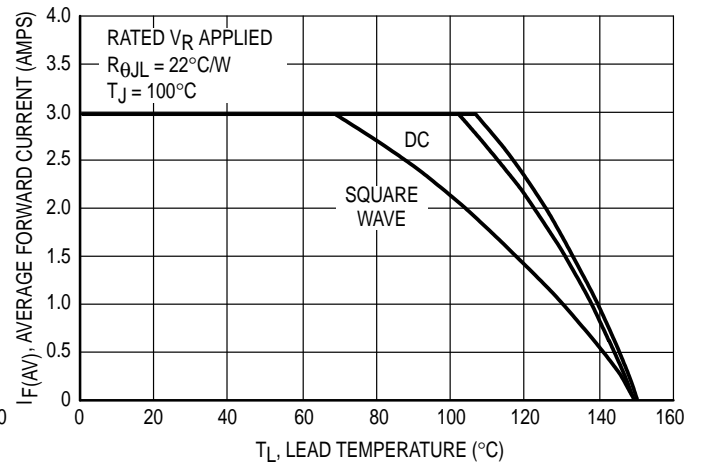

**Figure 4. Current Derating, Lead**

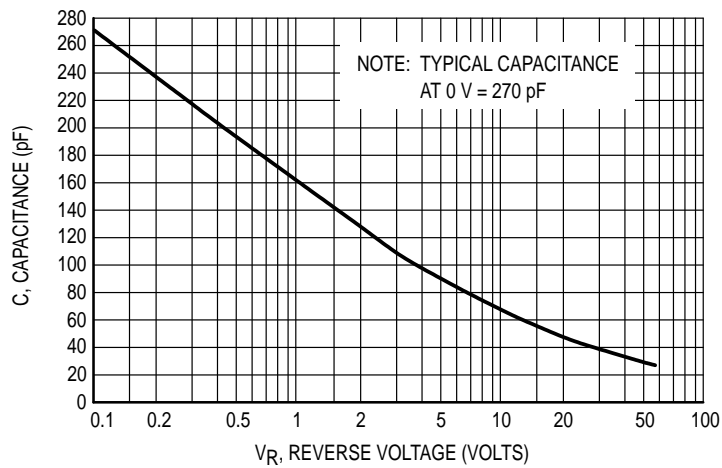

**Figure 5. Typical Capacitance**

## INFORMATION FOR USING THE SMB SURFACE MOUNT PACKAGE

### MINIMUM RECOMMENDED FOOTPRINT FOR SURFACE MOUNTED APPLICATIONS

Surface mount board layout is a critical portion of the total design. The footprint for the semiconductor packages must be the correct size to insure proper solder connection interface

between the board and the package. With the correct pad geometry, the packages will self align when subjected to a solder reflow process.

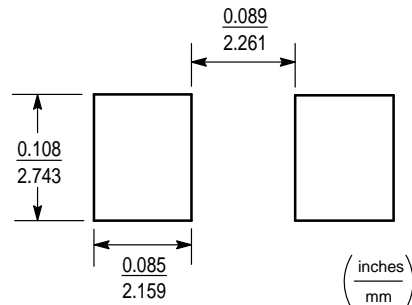

### MOUNTING PRECAUTIONS

The melting temperature of solder is higher than the rated temperature of the device. When the entire device is heated to a high temperature, failure to complete soldering within a short time could result in device failure. Therefore, the following items should always be observed in order to minimize the thermal stress to which the devices are subjected.

- Always preheat the device.
- The delta temperature between the preheat and soldering should be 100°C or less.\*
- When preheating and soldering, the temperature of the leads and the case must not exceed the maximum temperature ratings as shown on the data sheet. When using infrared heating with the reflow soldering method, the difference shall be a maximum of 10°C.
- The soldering temperature and time shall not exceed 260°C for more than 5 seconds.
- When shifting from preheating to soldering, the maximum temperature gradient shall be 5°C or less.
- After soldering has been completed, the device should be allowed to cool naturally for at least three minutes. Gradual cooling should be used as the use of forced cooling will increase the temperature gradient and result in latent failure due to mechanical stress.
- Mechanical stress or shock should not be applied during cooling

\* Soldering a device without preheating can cause excessive thermal shock and stress which can result in damage to the device.

**PACKAGE DIMENSIONS**

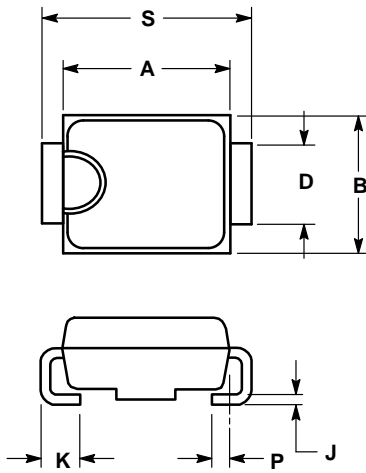

- NOTES:
1. DIMENSIONING AND TOLERANCING PER ANSI Y14.5M, 1982.
  2. CONTROLLING DIMENSION: INCH.
  3. D DIMENSION SHALL BE MEASURED WITHIN DIMENSION P.

DIM	INCHES		MILLIMETERS	
	MIN	MAX	MIN	MAX
A	0.160	0.180	4.06	4.57
B	0.130	0.150	3.30	3.81
C	0.075	0.095	1.90	2.41
D	0.077	0.083	1.96	2.11
H	0.0020	0.0060	0.051	0.152
J	0.006	0.012	0.15	0.30
K	0.030	0.050	0.76	1.27
P	0.020	REF	0.51	REF
S	0.205	0.220	5.21	5.59

**CASE 403A-03  
ISSUE B**

Motorola reserves the right to make changes without further notice to any products herein. Motorola makes no warranty, representation or guarantee regarding the suitability of its products for any particular purpose, nor does Motorola assume any liability arising out of the application or use of any product or circuit, and specifically disclaims any and all liability, including without limitation consequential or incidental damages. "Typical" parameters which may be provided in Motorola data sheets and/or specifications can and do vary in different applications and actual performance may vary over time. All operating parameters, including "Typicals" must be validated for each customer application by customer's technical experts. Motorola does not convey any license under its patent rights nor the rights of others. Motorola products are not designed, intended, or authorized for use as components in systems intended for surgical implant into the body, or other applications intended to support or sustain life, or for any other application in which the failure of the Motorola product could create a situation where personal injury or death may occur. Should Buyer purchase or use Motorola products for any such unintended or unauthorized application, Buyer shall indemnify and hold Motorola and its officers, employees, subsidiaries, affiliates, and distributors harmless against all claims, costs, damages, and expenses, and reasonable attorney fees arising out of, directly or indirectly, any claim of personal injury or death associated with such unintended or unauthorized use, even if such claim alleges that Motorola was negligent regarding the design or manufacture of the part. Motorola and  are registered trademarks of Motorola, Inc. Motorola, Inc. is an Equal Opportunity/Affirmative Action Employer.

Mfax is a trademark of Motorola, Inc.

**How to reach us:**

**USA/EUROPE/Locations Not Listed:** Motorola Literature Distribution;  
P.O. Box 5405, Denver, Colorado 80217. 303-675-2140 or 1-800-441-2447

**JAPAN:** Nippon Motorola Ltd.: SPD, Strategic Planning Office, 4-32-1,  
Nishi-Gotanda, Shinagawa-ku, Tokyo 141, Japan. 81-3-5487-8488

**Mfax™:** RMFAX0@email.sps.mot.com – TOUCHTONE 602-244-6609  
– US & Canada ONLY 1-800-774-1848

**ASIA/PACIFIC:** Motorola Semiconductors H.K. Ltd.; 8B Tai Ping Industrial Park,  
51 Ting Kok Road, Tai Po, N.T., Hong Kong. 852-26629298

**INTERNET:** <http://motorola.com/sps>

